

Reed RelayMate

from Pickering Electronics



Edition 1b

Reed RelayMate

This book provides an overview of how reed relays work how they are constructed and how to interpret their specifications and make best use of them in their applications.

It is intended to be a practical book about reed relays aimed at engineers. It requires little or no theoretical knowledge about the materials they are constructed from, all the issues are dealt with in a practical manner.

With the information supplied in this book we hope users will better understand the efforts that go into designing what in principle is a simple component but which in practice is a complicated product full of engineering compromises and best value judgements.

Created by the team at Pickering Electronics, April 2011

About Pickering Electronics

Pickering Electronics was formed in January 1968 to design and manufacture high quality reed relays, intended principally for use in instrumentation and automatic test equipment.

Pickering Electronics offer an extensive range of high quality instrumentation grade reed relays designed for applications requiring the highest levels of performance and reliability at an affordable price. Through the experience of supporting the most demanding manufacturers of large ATE systems with high relay counts the company has refined its assembly and quality control methods to optimise its manufacturing methods.

Working with its sister company, Pickering Interfaces, Pickering Electronics has developed innovative reed relay solutions designed to provide high coil efficiency, low switch volume and low PCB footprint solutions to meet the demands of modern equipment manufacturers.

© COPYRIGHT (2021) PICKERING ELECTRONICS. ALL RIGHTS RESERVED.

No part of this publication may be reproduced, transmitted, transcribed, translated or stored in any form, or by any means without the written permission of Pickering Electronics.

Technical details contained within this publication are subject to change without notice.

CONTENTS

Reed Relay Basics.....	3
Reed Switch	3
Generating the magnetic field	5
Protection against Magnetic Fields	6
Mercury Reed Relays.....	7
High Voltage Reed Relays	7
Normally Closed Reeds.....	8
Changeover Reeds	8
Two Pole Relays.....	9
Comparing Reed Relays with Other Relay Technologies.....	10
Electro Mechanical Relays (EMRs).....	10
Solid State Relays.....	11
MEMs (Micro Electro-Mechanical Machines).....	11
Packaging Reed Relays	12
Manufacturing Test of Reed Relays.....	14
Pickering Relays Test Methods	14
Choosing a Reed Relay.....	16
Signal Voltage, Current and Power Specification.....	16
SMD or Thru Hole Mounting.....	16
Diode or No Diode.....	17
Coil Voltage	18
Magnetic Screen	18
Electrostatically Screened Relays.....	19
RF Relays.....	20
Placing and Driving a Reed Relay Coil.....	20
Magnetic Field Interaction	20
Transistor Driving	20
LED Driving	21
Logic Driving.....	21
Loading Reed Relays	22
Resistive Loads.....	22
Capacitive Loads.....	22
Inductive Loads	22
Understanding Specifications.....	23
Carry Current.....	23
Lifetime.....	23
Minimum Switch Capacity	24
Hot Switching	24
Operating Speed	24
Soft and Hard Weld Failures	25
Thermoelectric EMF.....	25

CONTENTS

Relay Terminology	26
Form A.....	26
Form B.....	27
Form C (Change-over - break-before-make).....	27
Form D (Change-over - make-before-break).....	27
Latching Relay.....	27
Safety Relay.....	28
Product Gallery.....	28

Reed Relay Basics

Reed relays are deceptively simple devices in principle. They contain a reed switch, a coil for creating a magnetic field, an optional diode for handling back EMF from the coil, a package and a method of connecting to the reed switch and the coil to outside of the package. The reed switch is itself a simple device in principle and relatively low cost to manufacture thanks to modern manufacturing technology.

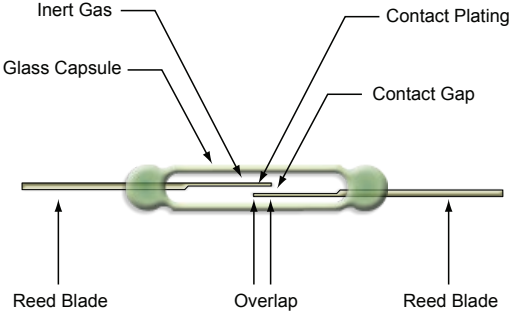

Reed Switch

The reed switch has two shaped metal blades made of a ferromagnetic material (roughly 50:50 nickel iron) and glass envelope that serves to both hold the metal blades in place and to provide a hermetic seal that prevents any contaminants entering the critical contact areas inside the glass envelope. Most (but not all) reed switches have open contacts in their normal state.

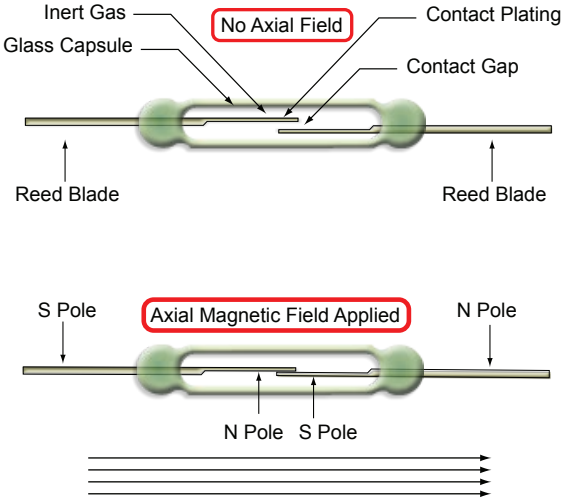

If a magnetic field is applied along the axis of the reed blades the field is intensified in the reed blades because of their ferromagnetic nature, the open contacts of the reed blades are attracted to each other and the blades deflect to close the gap. With enough applied field the blades make contact and electrical contact is made.

The only movable part in the reed switch is the deflection of the blades, there are no pivot points or materials trying to slide past each other. The reed switch is considered to have no moving parts, and that means there are no parts that mechanically wear. The contact area is enclosed in a hermetically sealed envelope with inert gasses, or in the case of high voltage switches a vacuum, so the switch area is sealed against external contamination. This gives the reed switch an exceptionally long mechanical life.

Inevitably in practice the issues are a little more complicated. The ferromagnetic material is not a good conductor and in particular the material does not make a good switch contact. So the reed blades have to have a precious metal cover in the contact area, the precious metal may not stick to the blade material very well so an underlying metal barrier may be required to ensure good adherence. Some types of reed relay use mercury wetted contacts, consequently reed relays that use plated contacts are often referred to as “dry” reed relays. The metals can be added by selective plating or by sputtering processes. Where the reed blade passes through the glass envelope any plating (in many cases there may be none) requires controlling to avoid adversely affecting the glass to metal hermetic seal. Outside the glass seal the reed blades have to be suitably finished to allow them to be soldered or welded into the reed relay package, usually requiring a different plating finish to that used inside the glass envelope.

The materials used for the precious metal contact areas inside the glass envelope have a significant impact on the reed switch (and therefore the relay) characteristics. Some materials have excellent contact resistance stability; others resist the mechanical erosion that occurs during hot switch events. Commonly used materials are ruthenium, rhodium and iridium— all of which are in the relatively rare platinum precious metal group. Tungsten is often used for high power or high voltage reed switches due to its high melting point. The material for the contact is chosen to best suit the target performance - bearing in mind the material chosen can also have a significant impact on manufacturing cost.

Another design variable on the reed switch is its size. Longer switches do not have to deflect the blades as far (measured by angle of deflection) as short switches to close a given gap size between the blades. Short reeds are often made of thinner materials so they deflect more easily but this clearly has an impact on their rating and contact area. Smaller reed switches allow smaller relays to be constructed – an important consideration where space is critical. The larger switches may be more mechanically robust and have greater contact area, improving their signal carrying capability.

It is these compromises in reed switch design that gives rise to the sometimes bewildering range of reed relays that are available with both subtle and not so subtle differences in performance.

Generating the magnetic field

To create a relay a magnetic field needs to be created that is capable of closing the reed switch contacts. Reed switches can be used with permanent magnets (for example to detect doors closing) but for the reed relays described in this book the field is generated by a coil which can have a current passed through in response to a control signal. The coil surrounds the reed switch and generates the axial magnetic field needed to close the reed contacts.

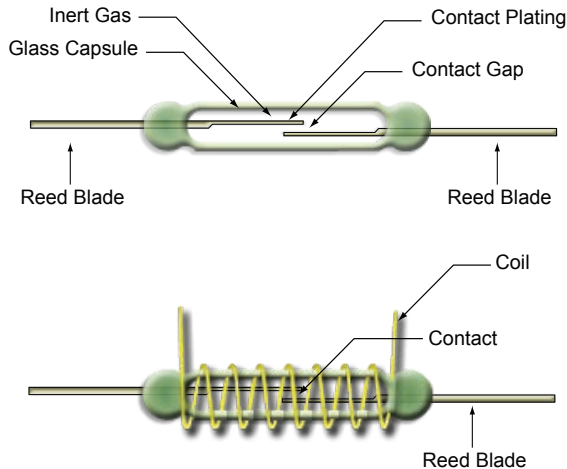

Different reed switches require different levels of magnetic field to close the contact, and this is usually quoted in terms of the ampere turns (AT) – simply the product of the current flowing in the coil multiplied by the number of turns. Again this creates a great deal of variation in the reed relay characteristics. Stiffer reed switches for higher power levels or high voltage switches with larger contact gaps, usually require higher AT numbers to operate, so the coils require more power.

Use of different wire gauges for the coil and number of turns creates relays with different drive voltage requirements and different coil powers. The resistance of the wire coil controls the amount of steady state current flowing through the coil and therefore the power the coil consumes when the contacts are closed. Whenever fine wires are used in Pickering relays, the termination leads from the coils are skeined with several strands of wire twisted together to increase their physical strength.

Larger coils can be used to reduce power consumption, but that increases the size of the relay.

A significant factor in some designs is the ability to drive reed relays with standard CMOS logic, requiring that the coil is operated from 5V or 3.3V and that the current (power) requirements in the coil are minimized.

Protection against Magnetic Fields

The fact that reed relays are magnetically operated causes a potential problem for users when they are assembled in dense patterns on PCB's

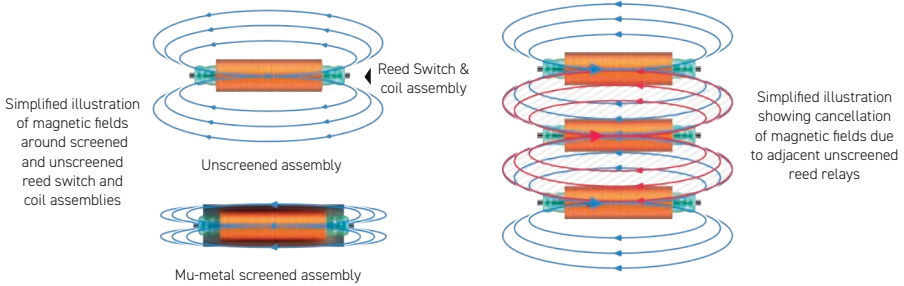

The magnetic field required to close the reed blades flows through the nickel iron reed blades and returns by field lines which are outside the reed relay body. If several relays are placed close together the external field lines can be drawn by the neighbouring reed blades and either reinforce or partially cancel the field in the reed, changing the current needed to close or open the contact. This can in some circumstances cause enough effect that the relay may either fail to close or open depending on the magnetic polarity. Some manufacturers suggest arranging the relays in different polarity patterns to mitigate the worst effect of the interaction, but this can become a complex compromise in dense arrays of relays where there are many near neighbours.

A much more sensible approach is to include a magnetic shield in the reed relay package, an approach used by Pickering Electronics for many years. The user is then free to use a layout pattern that best suits the application. The approach has the added benefit of improving the coil efficiency since it concentrates the magnetic field lines closer to the reed switch body, shortening the magnetic field length outside the reed blades and creating a larger field for a given number of ampere turns in the coil. Lower coil operating currents make coil driving simpler and improves other parameters like thermoelectric emf generation.

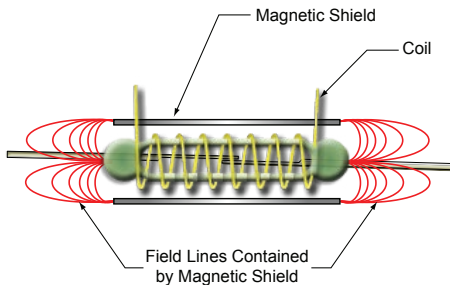

Mercury Reed Relays

There is a class of reed relays that has been historically very popular where the reed contacts include mercury that provides the electrical contact between the blades. The mercury is provided by a small reservoir which blade actuation tends to pump up a grooved surface on the reed blade to the contact area using mercury's high surface tension to retain the material.

Selective chrome plating is often used in the construction since mercury and chrome do not stick together and this is used to help control the mercury.

The glass envelope of mercury relays is also highly pressurised (typically 12 to 14 bar) which helps to manage the switch materials and operation and to improve electrical parameters.

These relays are strongly preferred in some industries because they have a long contact life and bounce free contact closure – a feature that is particularly helpful under hot switch conditions. Stability of low contact resistance during their operational life is considered to be better than that of dry reed relays.

Most types of mercury reed relays are position sensitive – they can only be used in a vertical orientation. Some non position sensitive versions are also available which can be used in any orientation. Mercury wetted relays however are not RoHS compliant and national regulations may limit their use to certain critical applications where exceptions on RoHS have been granted.

High Voltage Reed Relays

High voltage reed relays in addition to having to ensure high clearance distance (including the distance between the contacts in the reed switch) have to have a carefully match operating environment and different contact materials to resist the contact erosion that occur when switching the signals. High voltage reed switches commonly use tungsten or rhodium contacts.

The glass envelope for high voltage reed switches is normally a very hard vacuum to maximise the voltage rating for a given blade separation and to manage arc duration as the contacts open or close. Any loss of seal will rapidly degrade the switch operation so reed switches have to be carefully managed as they are packaged into reed relays.

Normally Closed Reeds

Most of the information in this book relates to normally open reed relays – by far the most common configuration of reed relay. However, normally closed relays can also be supplied where the blade is biased so it is normally closed and the application of a magnetic field opens the relay contacts.

The contact bias is created by adding an internal permanent magnet to hold the reed switch in a normally closed state. When the relay coil is energised it cancels out the magnetic field bias and the contacts open. If the coil voltage is increased substantially beyond its nominal voltage (typically greater than 1.5 times nominal) there is a risk that the contact will reclose.

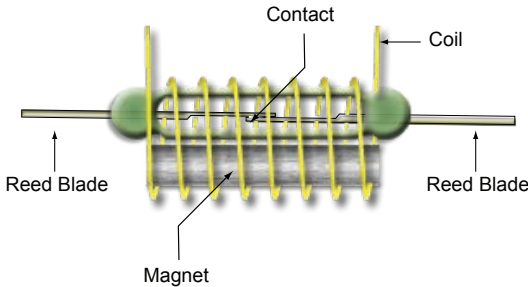

Not surprisingly normally closed relays are more difficult to manufacture and have higher magnetic interaction due to the bias magnet.

Changeover Reeds

Reed relays can be supplied with changeover switches – the reed switch has a normally closed contact (when no magnetic field is applied) and a normally open contact (which closes when the field is applied). The reed switch closed contact uses the blade as a spring bias with a non ferrous spacer to avoid completing a magnetic circuit. The coil field moves the blade to the normally open contact blade which does not have this spacer. As the reed relay switch blades transition between the two states for a brief period neither contact is closed – and important consideration in some applications.

The normally closed position relies on contact pressure being created by the spring bias of the blade. As well as being much harder to manufacture than normally open reed relays the two contacts, normally closed and normally open, can have quite different characteristics and stability. Experience is generally that they have a slightly less stable contact resistance than their simpler normally open counterparts. Even so, they perform a useful function for many applications because unlike the use of two normally open reed relays used to create a changeover function they only need one coil drive and it is mechanically not possible to have both contacts closed at the same time.

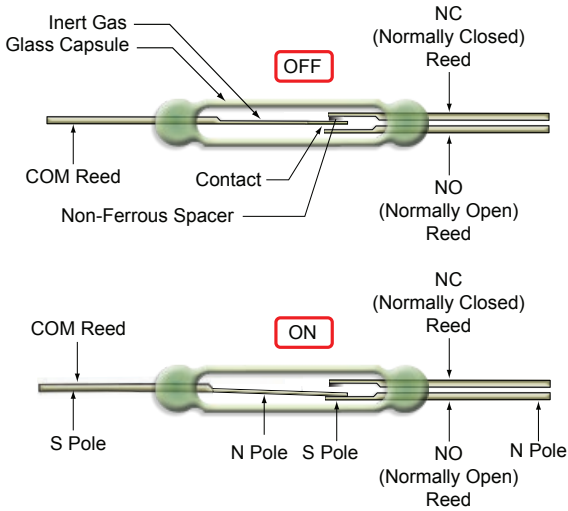

Two Pole Relays

Reed relays can also be supplied as 2 pole relays where two reed switches are contained in the same package and operated by a common coil drive.

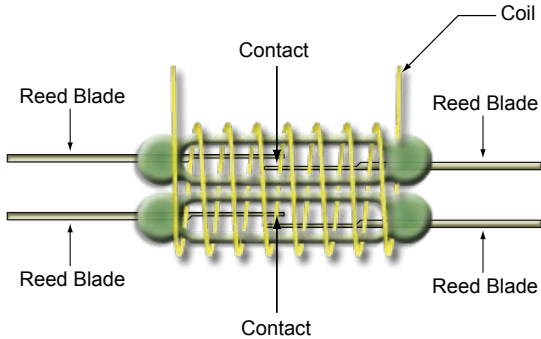

It is important to remember that these relays do not have an interlock mechanism between the two, it is unsafe to assume that the two poles operate at exactly the same time and the two reed switches are essentially independent. There could be an operate time difference of between 50 - 250 microseconds between them. Failure in one (say a contact weld) will not stop the other contact from moving.

Comparing Reed Relays with Other Relay Technologies

There are other relay technologies available to users with different characteristics to reed relays, some applications are best served by these alternatives and others are best served by reed relays. This section is intended to give some objective comparison information on the differences.

Electro Mechanical Relays (EMRs)

Electro Mechanical Relays are widely used in industry for switching functions and can often be the lowest cost relay solution available to users. Manufacturers have made huge investments in manufacturing technology to make the relays in high volumes.

There are some notable differences between reed relays and EMRs which users should be aware of:

- Reed relays generally exhibit much faster operation (typically between a factor of 5 and 10) than EMRs. The speed differences arise because the moving parts are simpler and lighter compared to EMRs.
- Reed relays have hermetically sealed contacts which lead to more consistent switching characteristics at low signal levels and higher insulation values in the open condition. EMRs are often enclosed in plastic packages which give a certain amount of protection, but the contacts over time are exposed to external pollutants, emissions from the plastic body and oxygen and sulphur ingress.
- Reed relays have longer mechanical life (under light load conditions) than EMRs, typically of the order of between a factor of 10 and 100. The difference arises because of the lack of moving parts in reed relays compared to EMRs.
- Reed relays require less power to operate the contacts than EMRs.
- EMRs are designed to have a wiping action when the contacts close which helps to break small welds and self clean their contacts. This does help lead to higher contact ratings but may also increase wear on the contact plating.
- EMRs can have much higher ratings than reed relays because they use larger contacts, reed relays are usually limited to carry currents of up to 2 or 3 Amps. Because of their larger contacts EMRs can also often better sustain current surges.
- EMRs typically have a lower contact resistance than reed relays because they use larger contacts and can normally use materials of a lower resistivity than the nickel iron used in a reed switch capsule.

Reed relays and EMRs both behave as excellent switches. The use of high volume manufacturing methods often makes EMRs lower cost than reed relays but within the achievable ratings of reed relays the reed relay has much better performance and longer life.

Solid State Relays

Solid state relay refers to a class of switches based on semiconductor devices. There is a large variety of these switches available. Some, such as PIN diodes, are designed for RF applications but the most commonly found devices that compete with reed relays are based on FET switches. A solid state FET switch uses two MOSFET in series and an isolated gate driver to turn the relay on or off. There are some key differences compared to a reed relay:

- All solid state relays have a leakage current associated with their semiconductor heritage, consequently they do not have as high an insulation resistance. The leakage current is also non linear. The on resistance can also be non-linear, varying with load current.
- There is a compromise between capacitance and path resistance, relays with low path resistance have a large capacitive load (sometimes measured in nF for high capacity switches) which restricts bandwidth and introduces capacitive loading. As the capacitive load is decreased the FET size has to decrease and the path resistance increases. The capacitance of a solid state FET switch is considerably higher than a reed relay.
- Reed relays are naturally isolated by the coil from the signal path, solid state relays are not so an isolated drive has to be incorporated into the relay.
- Solid state relays can operate faster and more frequently than reed relays.
- Solid state relays can have much higher power ratings.

In general reed relays behave much more like perfect switches than solid state relays since they use mechanical contacts.

MEMs (Micro Electro-Mechanical Machines)

MEMs switches are still largely in the development stage for general usage as a relay. MEMs switches are fabricated on silicon substrates where a three dimensional structure is micro machined (using semiconductor processing techniques) to create a relay switch contact. The contact can then be deflected either using a magnetic field or an electrostatic field.

Much has been written about the promise of MEMs switches, particularly for RF switching, but availability in commercially viable volumes at the time of writing is very limited. The technology challenges involved have resulted in a number of vendors involved in MEMs failing and either ceasing to trade or closing down their programs.

Like reed relays MEMs can be fabricated so the switch part is hermetically sealed (either in a ceramic package or at a silicon level) which generally leads to consistent switching characteristics at low signal levels. However, MEMs switches have small contact areas and low operating forces which frequently leads to partial weld problems and very limited hot switch capacity.

The biggest advantage for MEMs relays – if they can be made reliable - is their low operating power and fast response. The receive/transmit switch of a mobile phone for example has long been a target for MEMs developers.

However, at their present stage of development it seems unlikely they will compete in the general market with reed relays as the developers concentrate on high value niche opportunities and military applications.

Packaging Reed Relays

The reed switch and coil assembly have to be assembled into a package so that users can conveniently handle them and assemble them to printed circuits boards.

The package itself has to be robust but also has to allow the components to expand and contract without damage over long periods of time with constant operation of the coil causing temperature changes in the relay assembly. This can happen thousands of times per day.

Different manufacturers have different ways of approaching the packaging problem that they have developed and refined over many years of experience of constructing and testing the relays.

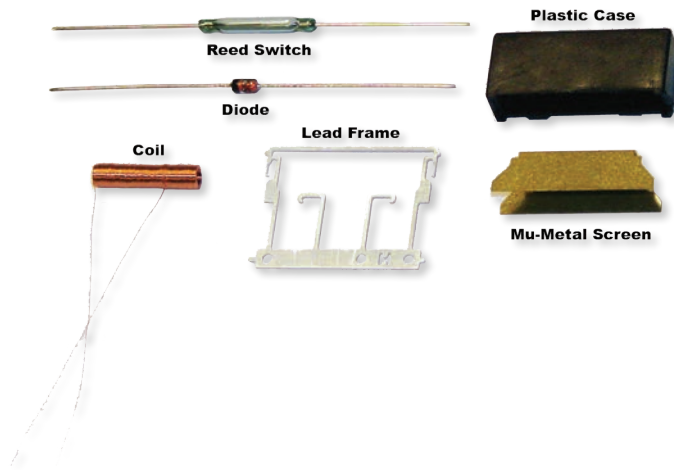

The most common construction methods are based on the use plastic mouldings to protect the reed relay assembly, and this is the method used in Pickering Electronics.

The relay components are first assembled on a lead frame made from stamped or chemically etched metals. The lead frame has some similarities to the lead frames used in semiconductor manufacture. The lead frame is held together by a metal frame that is removed when the reed relay is finally assembled. The reed switch, coil and coil diode (if fitted) are attached to the lead frame by soldering or welding (Pickering Electronics use a welded construction for the reed switch to improve reliability during assembly to PCB) so the components are firmly secured to the lead frame.

Great care has to be taken at this stage of assembly to ensure the continued reliability of the components, in particular care has to be taken that the reed switch blades attached to the lead frame have to be cropped without damaging the reed to glass seal and without moving the blades within their glass envelope.

The lead frame and its components are then inserted into a hollow plastic moulding and then the moulding is filled with appropriate encapsulation materials.

Pickering Electronics have refined the process of packaging to include several unique features that improve the reed relay performance:

- The coil is wound without a former to reduce the number of parts and improve the efficiency of the coil. The use of a former to wind the coil on takes up space and reduces the magnetic field in the reed switch when the coil is energized.
- The lead frame assembly methods have been refined to improve the reed relay reliability.
- Inclusion of internal magnetic screens to prevent relay interaction.
- The use of **SoftCenter™** construction with the inner packaging materials allowing for the movement of components under temperature cycling conditions without fear of coil or glass breakage.

Typical Pickering Construction using Former-less Coils and our **SoftCenter™** technology

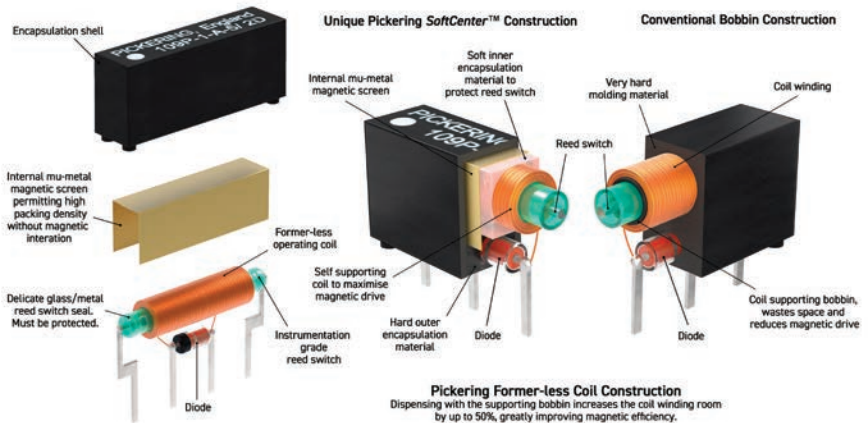

This **SoftCenter™** construction method lends itself well to packages for thru-hole plated relay reed relays and is uniquely also used by Pickering for surface mount relays.

Manufacturing Test of Reed Relays

The manufacturing tests performed on reed relays are critical to the quality and the life of the end product. A manufacturer of high quality reed relays will test a number of key parameters to try to discover reed switches which have performance issues and to establish that the packaging of the switches into a relay with its actuation coil has not introduced any issues. Experience of reed relay manufacturers is that it is hard, almost impossible, to achieve the high reliability levels that demanding users require without performing an extensive set of tests. Reed relay manufacture and reed switch quality vary sufficiently to demand that high quality needs 100% test of many parameters and quality control tests on other parameters.

The tests are designed to find issues that might impact reliability, not just tests that find faulty devices on a go/no go basis. Some typical issues that are tested for include:

- Reed blade misalignment, either from faulty switches or from disturbance to the switch during the manufacturing process.
- Failed glass seals on reed switch.
- Coil breakages.
- Coil operating voltage failures.
- Contact contamination or misalignment.

Different vendors have different methods for finding these faults based on their experience in manufacturing reed relays and from the failure returns and analysis they have historically gathered as part of a continuous process improvement.

Pickering Relays Test Methods

All the primary characteristics are tested on every relay prior to shipment as detailed in the following pages. For long and reliable life however, the most critical test performed is on contact resistance stability and variation. One specialist test, developed by Pickering, involves driving the relay with varying coil drive levels and measuring the changes in contact resistances that are seen as a consequence. This test will find minor contact misalignments or contamination allowing rejection of marginal parts that might otherwise become early life failures.

In addition to the contact stability test a full set of tests is also conducted on ATE for every Pickering relay, the example below is for a simple single pole Form A type:

- **Adaptor continuity.** All ATE test are performed using a Kelvin (four terminal) connection technique. For every relay tested the fixture integrity is measured.
- **Coil resistance.**
- **Diode (if fitted).** This is tested by measuring the voltage drop of the forward biased diode.
- **Operate time.** Time taken from the application of the coil drive to when the contact is closed.
- **Contact bounce period and numbers of bounces.**

- **Release time.** Time taken from the removal of the coil drive to when the contact opens.
- **Operate voltage.** The actual voltage that is required on the coil to operate the contact. This is determined by applying an increasing ramp voltage to the coil until the switch operates. For catalogue items, the specification is less than 75% of the nominal coil voltage. This can be specified with other figures for special parts.
- **Release voltage.** The actual voltage that the coil drive needs to fall to, for the contact to open. This is determined by applying a decreasing ramp voltage to the coil until the switch opens. For catalogue items, the specification is greater than 10% of the nominal coil voltage. This can be specified with other figures for special parts.
- **Contact resistance.** This is the resistance of the complete switch path.
- **Delta-Contact resistance.** This is the measure of small changes in contact resistance versus small changes in coil drive volts. Measurements are taken at increments just above the operate voltage point and the release voltage point. This test will detect problems with contact alignment, contamination or other factors that are often not found with a simple static contact resistance test.
- **Insulation resistance.** This is measured between the switch and the coil connections and between open switch contacts. This is usually in excess of 10^{12} Ohms.
- **Isolation voltage.** The stand-off voltage between the switch terminals and the coil and between open switch contacts.

Choosing a Reed Relay

Signal Voltage, Current and Power Specification

All reed relays have specified voltage and current ratings that need to be kept within if the reed relay is to have a long service life. It is important to be clear if the application envisages hot switch or cold switching (see Understanding Specifications), it can have a substantial impact on the cost and size of the relay used. If hot switching is likely to occur the most common mistake is to ignore the power rating of the reed relay, the fact a particular relay may be capable of 100V and 1A does not mean it can hot switch a signal with these extremes of value. A 10W reed relay for example will only switch a 100V, 100mA signal reliably.

If hot switching is not expected to happen then the user can rely on the carry current rating and to withstand the rated voltage across the contacts.

SMD or Thru Hole Mounting

Users often have a choice of using thru hole components or surface mount packages for reed relays.



With other component types the choice may be driven in part by the density that can be achieved on a PCB, however this is not always the case with reed relays. Reed relays are not particularly small devices by modern standards as magnetic interaction can be a real problem on some systems (though not on Pickering Electronics based solutions where the built in magnetic shield prevents problems).

Manufacturing processes may prefer to use SMD components, in which case there are solutions which are available for most applications. However, the choice is more difficult when the relay is considered to be a potential service item. The relay could be considered to be a service item if it is frequently exposed to hot switching events which might wear out the contact materials or where (as is the case in ATE systems) connection to faulty devices or even programming errors can result in the relay being damaged.

Removing surface mounted components is an intrusive procedure – even using specialist de-soldering tools not only the component to be removed but also adjacent components are subject to heating, solder reflow and stress. In these circumstances thru hole components are much easier to manage and require no specialist de-soldering tools or high operator skills. It is more likely the item can be serviced locally, and it is less likely to cause damage elsewhere in the assembly.

For applications where relays may have to be serviced Pickering Electronics recommend that thru hole components are used. Outside of these applications the choice is driven by user manufacturing preferences and the component choices such as footprint area, relay ratings and relay height.

Diode or No Diode

Reed relays often have a choice to include an internal protection diode or not (in comparison this is never the case with EMRs).

The purpose of this diode is sometimes misunderstood, it is present primarily to protect the device that is driving the relay coil from the Back EMF that is generated when the current flow is interrupted.

Assuming the relay coil driver operates with an open collector drive then while the driving device is on the current flow is limited by the resistance of the relay coil. When the open collector is turned off the voltage on the output tries to rise and the current tries to drop, but the open collector drive has no conduction path to allow this to happen. The conducted current has to fall to zero to collapse the magnetic field in the coil. So the driver output voltage rises rapidly, the rate of rise being limited only by characteristics such as coil or driver capacitance. Eventually the voltage rise will limit as the driver output starts to enter voltage breakdown. This is a large impulse load for the driver and may result in premature failure.

The normal solution for this is to include a diode to protect the driver, when the driver output rises above the coil supply voltage the diode conducts and clamps the output voltage. As the diode clamp voltage is much less than the breakdown voltage the peak instantaneous energy dissipated is much lower, and a diode is generally designed to better handle this surge than a transistor.

Not all drive methods though use open collector (or open drain) drives. If the driver always ensures an adequate return path for the coil current (for example when using logic to drive the coil) then no diode is needed.

It is also possible to modify the clamp arrangement to speed up the release time of the relay. The faster the coil field is discharged the sooner the relay contacts will start to move. In some applications (for example protection of a device from an externally detected surge, a specific example being reverse power protection on signal generators) the time to open a contact is crucially important to protect devices. In this case a modified protection that either clamps using series resistance with the diode or clamps to a voltage higher than the supply can considerably speed up the device opening time.

The impact on release times will vary between reed switches, but releases in the region of $40\mu\text{s}$ are achievable on some types of reed relay.

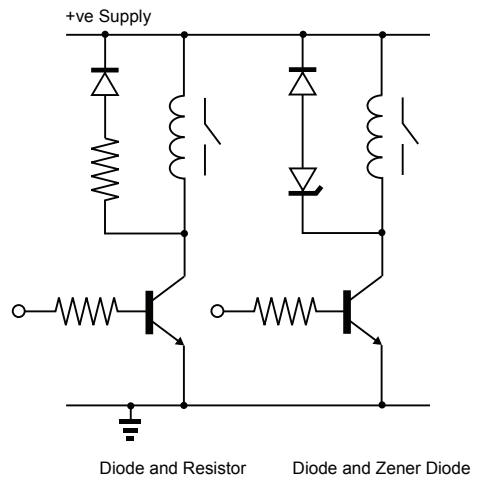

Coil Voltage

Reed relays are supplied with a wide variety of coil voltage options. For logic driving 3.3V and 5V drives are the preferred choice since these voltages are directly compatible with common logic families. However, all the coils for a given reed switch have to have a certain number of Ampere Turns as previously noted, so as coil voltage is dropped the coil current required is increased. For some applications high coil currents are undesirable – they might lead to power loss in power supplies (low voltage supplies are commonly less efficient than higher voltage supplies), losses on PCB traces and the creation of larger EMC transients.

LED drivers can directly support either 5V or 12V coils, open collector drivers can support even higher voltages. However, as coil voltage increases the wire used to create the relay coil becomes finer and harder to wind without breakages. Ultimately this limits the highest voltage coils that can be offered.

For many applications 5V coils are considered a good compromise.

One factor often ignored by users is the impact of temperature on coil current. Data sheets for relays will commonly show a pick up voltage and release voltage and this is usually at a significantly lower voltage than the nominal coil voltage required. There are four principal reasons for this margin:

- As temperature rises the coil resistance rises (by 0.39% per°C), the voltages are measured at more typical temperatures (25°C), so by the time the maximum rated temperature of the relay is reached the coil current can have dropped very significantly.
- The coil drivers will have an output resistance which may be significant.
- Actual power supply voltage can vary both from product to product and across a PCB used to distribute it.
- External magnetic fields might alter the coil current needed to achieve the required field strength.

Consequently reed relays should have a reasonable operating margin to ensure reliable operation in all conditions. The lowest voltage relay coils are the most vulnerable to this type of problem.

Magnetic Screen

In the case of Pickering relays this takes the form of either an internal mu-metal screen inside the plastic package or an external mu-metal can. A magnetic shield is added to the relay to serve three purposes:

- Reduce the effect of magnetic interaction between closely packed reed relays. The lack of a magnetic screen is of relatively little consequence from this perspective if the relay is used on its own with no other close relays or other magnetic field sources that might affect the operation of the relay contacts.
- Reduce injection of noise into the signal path by external magnetic fields.
- Increase the magnetic efficiency resulting in a reduction of the coil power needed.

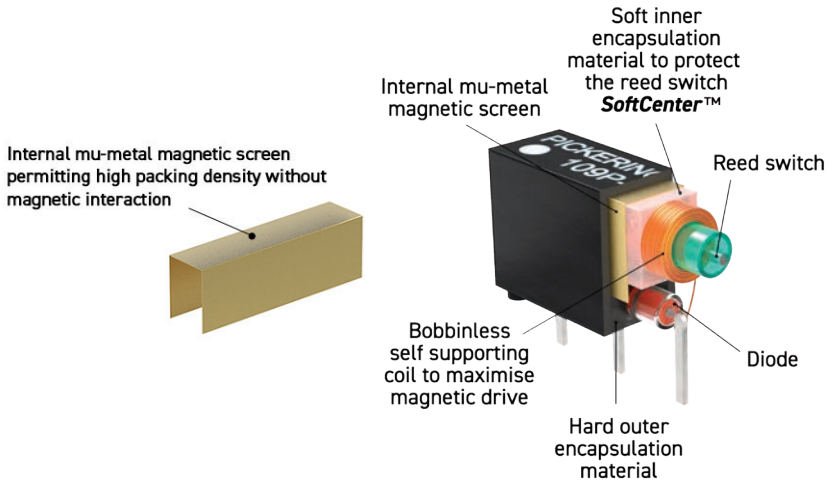

The magnetic shield is made of Mu metal which has a high permeability at low frequencies and DC. It deflects any external magnetic field around the relay body and the material has a low ability to retain a magnetic field when the coil current is interrupted. Magnetic shields using other materials are generally to be avoided since remanent magnetism can alter the operating point of the relay and create contact variability.

If relays are to be closely packed together then a relay should be chosen with an integrated magnetic shield.

Electrostatically Screened Relays

A reed switch is enclosed by a coil but is otherwise open to pick up from adjacent circuits. With a screened relay a foil layer is added between the coil and the glass body of the reed switch and a contact to the foil is brought out to the outside of the package. If this screen is earthed it can reduce the amount the signal that is picked up on the signal lines from either the coil itself or from other external signals. Coil pick up can be minimised by other measures, such as making sure that the coil is well decoupled to ground.

It should also be remembered that an electrostatic screen does not provide protection against an external magnetic field inducing signals into the signal path.

RF Relays

RF relays are designed to operate in defined transmission line impedance, usually 50 or 75Ω. In some ways reed relays seem almost perfect for such applications since the glass tube can be wrapped in a conductive tube and the two ends provided as an earth contact – the net effect looks rather like a length of coaxial cable. Provided the glass and blade dimensions are correct they form a coaxial transmission line.



In practice there are problems. Getting a short (non inductive) connection to the tube is problematic and in practice either unusual mounting techniques or multiple contacts have to be used.

The other problem is more practical, changeover switches tend to have very poor isolation between the contacts because of their construction (EMR solutions can use a much bigger contact separation and intermediate grounding planes to reduce interaction) but the better performing SPST (Form A) relays cannot be used to assemble switching networks without leaving un-terminated transmission line stubs which limit the bandwidth of the system to be considerably less than the bandwidth of the switch.

RF relay applications have to be designed with care since the issues are primarily about the overall system performance and not just the relay performance. If an application simply requires the disconnection of the signal path and not provide alternative routing (for example for a protection system) then reed relays can be a very good choice because of their fast response.

Placing and Driving a Reed Relay Coil

Magnetic Field Interaction

Reed switches are operated by magnetic fields provided by coils and bias magnetics within the reed relay assembly. For Pickering Electronics reed relays the inclusion of a magnetic screen ensures they can be densely packed together. However, it does not make them immune to magnetic fields generated by EMR relays or by other reed relays that do not include magnetic screens (or include ineffective screens). So when reed relays are used on PCB some care should be taken to avoid them being excessively close to parts that might generate a strong field, including disc drives and large inductors.

Transistor Driving

A common method of driving reed relays is to use either a bipolar transistor or an FET to directly drive the coil using an open collector/source. The coil can have one end connected directly ground or to a power supply – the most common method used to is to connect to a power supply so that a grounded transistor or FET can be used.

When driving with a transistor a diode has to be fitted to control the Back EMF voltage spikes generated when the coil drive voltage goes open circuit.

LED Driving

One consequence of the use of LEDs in modern systems has been the development of a large number of different LED drivers which can make excellent products for driving reed relays. LED drivers made by companies such as Macroblock and Texas Instruments.

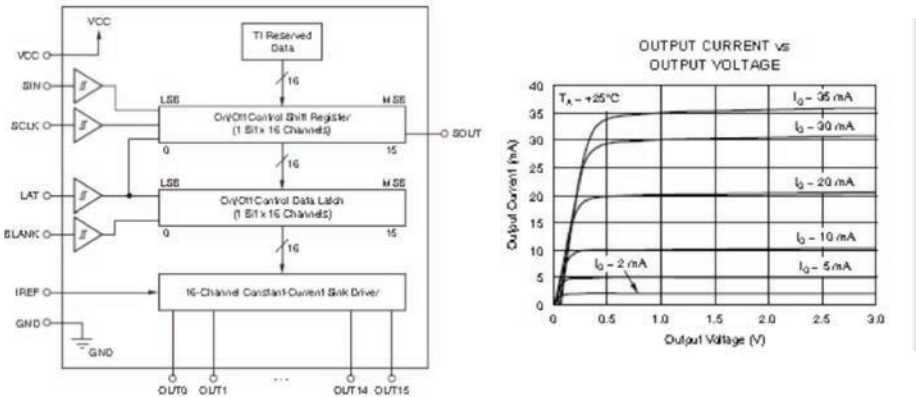

LED drivers are typically serial input devices with 16 outputs each of which is a current source limited by (typically) a single resistor. Using these outputs to drive reed relays is simply a matter of setting the current limit to (say) 50% more than that required by the reed relay connecting one end of the reed coil to the voltage supply and the other to the LED driver output. LED drivers are typically rated to 17V on their outputs so they can interface with most coil options. A back EMF protection diode should be used as described in the previous section.

A useful feature on LED drivers is that in the event the relay coil or connection becomes shorted the current flowing is limited. Many LED drivers also include diagnostic modes where open circuit loads (in this case coils) can be detected and reported via the serial control interface.

Logic Driving

Standard logic families can be used to drive 5V or 3.3V reed relays directly. The output of these logic families (excluding open collector or drain types) uses CMOS drivers which ensure that there is path either to ground or logic supply at all times. When they are used to drive relay coils the reed relay does not need a built in diode since no back EMF spike is generated. Because the drive is connected to either ground or supply in turn with no back EMF the release time for the relay may be longer than when driven by an LED driver or an open collector drive.

Pickering Electronics reed relays designed for 3.3V operation are designed with a 3V operating criteria since the voltage drop in the driver can be a significant issue. Designing the relays around 3V ensure good operation even when driven by 3.3V logic with a significant voltage drop in the drive circuit or the power supply.

Loading Reed Relays

Reed relays have an exceptionally long life when lightly loaded but the load conditions can have a dramatic effect on the life. A specification that includes a number of operations implies that a relay is being hot switched.

Resistive Loads

Reed relay specifications are always quoted for hot switching into purely resistive loads. The reason for this is that the test conditions are simple and easily reproduced, using any load result requires other conditions to be stated.

Capacitive Loads

Capacitive loads can be extremely destructive to all types of relays if the relay is closed with voltage applied to one terminal and a highly capacitive load is connected to the other terminal. When the contact closes the voltage appears across the capacitive load and a high current surge is created, the current and duration of the surge being limited by resistances, inductance in connections and the value of the capacitive load.

Capacitive loads are created not just by loads with capacitors attached but also by very long cable runs. Cabling of a few meters in length is unlikely to create an issue, but cabling measured in many 10's of meters in a system can be an issue. Cable forms might typically have a capacitance of the order of 100pF per metre.

Cable runs are also a cause of another reliability issue on relays – as they are commonly capacitive if a voltage is applied to a cable and then disconnected the cable could retain a residual voltage after the event, and the next time a connection is made the event can be classed as hot switching as the voltage is discharged on contact closure. It is usually wise to discharge long cable runs after connection to a voltage source.

The impact of hot switching capacitive loads is to reduce the contact life of the relay as though it was connected to a larger load than the users believes is present. Hot switching of capacitive loads is something that should be avoided unless the current surge is limited, perhaps by the inclusion of a defined source resistance.

Inductive Loads

In the same way that capacitive loads can impact relay life on contact closure with voltage source present then inductive loads can shorten relay life if the relay contact is opened when current is flowing. The consequence of opening the contact are similar for those described when driving the reed coil, the magnetic field in the inductor has to be collapsed and interruption of the current causes a large voltage spike (back EMF) to appear. This can erode the materials on the relay contact and again shorten the life of the relay.

There are ways of managing the inductive load problem but these are usually very specific to the load being switched. When used to operate DC solenoids for example a diode can be included to suppress the voltage spike.

Understanding Specifications

Carry Current

Carry current is the current that the reed relay can support through its contact without long term damage. The life of the relay should be indefinite under this condition though some reed relays may also have a pulse current rating which can be applied to the relay without damage.

The carry current is determined primarily by the contact resistance of the relay and the heat sinking to the environment. As the current increases the temperature of the reed blades increases until it reaches a temperature where the material is no longer ferromagnetic (Curie Temperature). Once that temperature is reached the relay contacts may open since the blades no longer respond to the magnetic field. The blade temperature is clearly dependent upon the current and relay path resistance – the normal assumption is that this is a square law (with current) relationship. In reality the temperature rise is significantly more than a square law since the metallic resistance also increases with temperature, the magnetic field drops with temperature because of coil resistance rise and the mechanical properties of the blade can change. Consequently like all relays, exceeding the rating can result in a type of thermal runaway.

The packaging of the reed switch has a significant impact on the temperature rise, a lead frame tends to conduct heat to the outside world while the plastic encapsulation materials insulate it. The packaged reed relay will ALWAYS have a lower current rating than that of the reed switch because manufacturers quote the rating with the reed switch directly exposed (no coil, no plastic packaging). The coil power will also add to the heating effect. Consequently Pickering Electronics always de-rates the reed relay ratings to ensure that the relay switch remains within its design limits.

There is also another subtle effect that occurs as the carry current increases – the signal creates its own magnetic field that twists the blades and therefore can modulate the contact resistance. The blade twisting may start to see a contact resistance rise as the blade contact area reduces or changes.

Care must be taken not to exceed the relays ratings and pulse ratings should take account of the square law relationship between current and temperature.

It becomes difficult to manufacture reed relays with a carry current of greater than 2A because the contact area has to be increased and that tends to make the bladed stiffer and require a higher magnetic field strength to operate them.

Lifetime

The lifetime of reed relays is critically dependent on the load conditions the reed switch encounters. For reed relays which are instrument grade the mechanical lifetime is much greater than 1 billion operations – they are mechanically simple devices that rely purely on the deflection of a blade to operate and there are consequently fewer wear out mechanisms.

The blade contact area though stills wears as they are opened and closed. If the signal load when the blade closes or opens is low then the wear out is very slow, as the load increases and hot switching (interruption or closure of a signal live carrying significant current or voltage) occurs higher temperatures are generated at the contact interface and this makes the materials more prone to wear. DC signals can also result in the migration of metal from one contact to another

and without regular polarity reversal eventually the underlying contact materials are exposed with their poorer conduction characteristics. Hot switching can also create a temporary plasma in the contact area with high local temperatures, rapid operation of a relay under load can start to raise the contacts temperature to an extent where premature wear out can occur.

The life an instrument grade reed relay can vary by three orders of magnitude according to the load conditions, perhaps 5 billion operations under no or light load to 5 million operations at a heavy load.

Minimum Switch Capacity

Some types of relay have a minimum switch capacity, if the relay is closed on a very low level signal (current or voltage) oxide or debris on the relay contacts can remain at the interface and cause a higher than expected resistance, or even an open circuit. This tends not to be the case with reed relays because the precious metal contacts are sealed in a hermetic glass envelope containing inert gas. Minimum switch capacity tends to be a characteristic of higher power mechanical (EMR) relays.

Hot Switching

Hot switching occurs whenever a relay contact is opened or closed with a signal (current and voltage) is present. As the contacts move apart or close an arc can be created which transfers material from one contact to another, or simply redistributing the material. As the contact plating is damaged the resistance will eventually start to rise until the relay is no longer fit for the intended application.

For reed relays hot switching tests are always conducted into resistive loads. The hot switch capacity of a reed relay is typically quoted at a current/voltage that results in the number of operations that the relay will support around 10million operations. The data sheet specifies a hot switch current (the limiting factor at low voltages), a hot switch voltage (limiting factor at low current) and a power (from the product of the open contact voltage and the closed contact current).

Operating Speed

The Operate Time is the time from when the relay coil is energized or de-energized to when the contact reaches a stable position.

For a normally open contact when the coil is energized the current, and therefore the magnetic field, in the coil rises until the blades start to move closer together until they make contact. The contacts may impact each other sufficiently rapidly that there is bounce where for a short duration the contact is intermittently closed then opened. The operate time should be the time from when the relay coil was energized until the contacts are stably closed.

If the coil is driven from a higher than specified coil voltage the closing speed of the relay will be faster, however once the contacts make there may be more contact bounce as they meet with greater force. Overdriving the coil can also increase the release time since the magnetic field takes longer to collapse to the point where the contacts start to open.

For a normally open Form A (SPST) contact the release time is the time from when the coil is de-energised to when the contact is open. This operate time can be dependent on how the reed relay is driven, the presence of a protection diode on the coil will increase the release time. Typically, the release time is around one half the operate time.

Soft and Hard Weld Failures

Operation of reed relays (or EMRs) under high load conditions causes one of the most common failure mechanisms for relays – a failure where the contacts are welded together. By convention these welds are classified as being either soft or hard failures. In the event of hard failure the contacts tend to be welded together and nothing will separate them. This is an easy fault to identify. Soft failures occur where the contacts stick but eventually come apart without any additional assistance. The failure is caused by small areas on the contact welding together, but the weld area is sufficiently small that the reed blades will separate because of their sprung nature. They could spring apart very quickly, or it may take several seconds to spring apart depending on how hard the weld is.

In either case the impact on the user is that the switching function of the relay is impaired and this is likely to have an adverse impact on the user application. So in either case the relay will require replacing since the defect is unlikely to improve with time. The cause of the weld will also need to be investigated and corrected.

Thermoelectric EMF

The cause of thermo electric voltages is often misunderstood by users, and often misrepresented in articles and on the internet. The effect of thermoelectric EMF's is to generate a small voltage (measured in microvolts) across the relay terminals when the relay is closed.

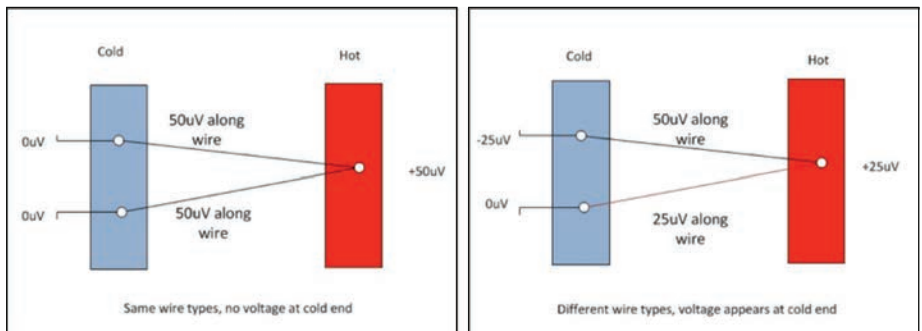

The voltage arises whenever a metal wire has a temperature gradient across it (the Seebeck Effect), if one end of the wire is at a different temperature to the other then a voltage will appear which is dependent on the temperature difference and the materials that make up the wire. Reed relays use a mix of metals, and these can have different temperature drops across them which results in a voltage appearing at the relay connection terminals. The voltage is not created at a connection junction. Nickel iron has quite a strong thermoelectric EMF, so designing reed relays with low thermal EMF's can be a challenge.

Reed RelayMate

The number and type of materials varies according to the way the reed switch is designed and how it is packaged. If the relay was perfectly symmetric in construction (so the materials used from each contact to the reed switch were the same and the reed itself was perfectly symmetric in all materials and dimensions) and all heat sources in the relay body (primarily due to the coil) then this would be the case. However in reality the symmetry is not perfect so a residual voltage will arise.

Users can also degrade the performance by how they use the relay. When mounted on a PCB if the PCB has a temperature profile across it then that will generate an additional thermal EMF. Relay manufacturers usually assume that the thermal EMF is zero when the relay is first closed since up to that point no heat source exists inside the relay body. However, a temperature profile across the PCB (caused by the presence of other heat sources or forced air cooling) will create a thermal EMF.

Reed relays that have excellent Thermal EMF performance are typically designed to be as symmetric in design as possible and to use highly efficient coils to avoid heating the reed switch. Typically though, this results in a physically larger relay.

Two pole designs often quote the Differential Thermal EMF, this is the voltage generated between the two switches (usually) in a single package. Assuming the relay design is reasonably symmetrical to a first order the voltage in one switch is the same as the other, so the differential voltage can be much smaller for the relay. Differential and single ended Thermo Electric EMF numbers should not be directly compared or confused with each other.

Relay Terminology

The relay industry has evolved with a set of its own nomenclature that describes the products that are available, not all of these terms are familiar to users. The following section seeks to describe these relay terms.

Form A

This reference describes a relay whose contact is a simple switch which is open or closed and the un-energised position is the open condition. For a single relay this would also be described as a single pole, single throw (SPST) relay with a normally open (NO) contact.

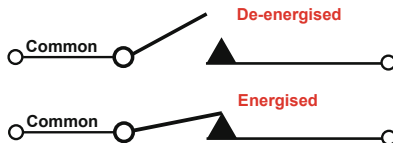

If the relay has multiple contacts in the same package it would be described as having (for example) 2 Form A contacts (DPST).

Form B

This reference describes a relay whose contact is a simple switch which is open or closed and the un-energised position is closed.

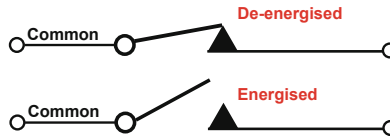

Form C (Change-over - break-before-make)

This reference describes a relay with two contact positions, the normally closed contact and the contact which becomes closed when the relay is energised. For a single relay this would also be known as a changeover switch or a single pole double throw (SPDT). If the relay has two contacts sets it would be described as 2 Form C contacts, or double pole double throw (DPDT).

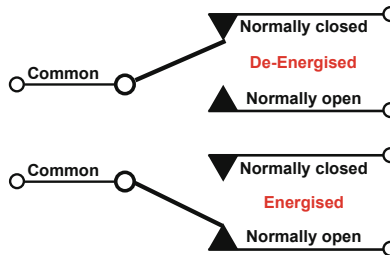

Form D (Change-over - make-before-break)

This reference is to a changeover relay that is designed to make contact with the second contact before releasing from the first contact. These relays are very rarely constructed from reed switches because of implementations issues.

Latching Relay

Latching relays have two or more stable positions for the contacts when power is not applied. To change the state of a relay a coil has a voltage transiently applied to it with a defined duration. Latching relays can be used for applications where minimisation of control power (coil current) is critical or where a power failure requires the switch to be left in the state it was set to until power is restored. The latter case needs careful design to avoid transient change instructions as the power fails. The latching mechanism usually relies on a magnet to provide the latching function.

Latching relays are generally not liked in modern software controlled systems because the software may not have direct knowledge of the relay state, particularly at power on. Some latching relays can have extra contacts to provide a direct indication of the contact position. This type of relay is not commonly available in reed relay form.

Safety Relay

Also known as a force guided contact relay this type of relay is designed with two or more contact sets (poles) and the mechanical design is such that if one contact one pole fails to change position because of a weld the other contact on another pole cannot close the corresponding contact. The mechanical design usually relies on forces being applied to close to the contacts. There are no commercial solutions for a safety relay using reed switches.

Product Gallery

High Density Vertical SIL Reed Relays

- Ideal for Very High and High Density ATE/Instrumentation applications
- Plastic package with internal mu-metal magnetic screen
- 3V, 5V, or 12V coils. Diodes are Optional
- Dry Instrument Grade switches
- SoftCenter™ Technology

Series 117

- 10 Watts, 0.5 Amp switching in 1 Form A & 2 Form A



Series 116

- 10 Watts, 0.5 Amp switching, requires a board area of only 0.15 x 0.27 inches



Series 115

- Pin compatible with Series 116 and 117 but using same switches as the Series 109 & 109P



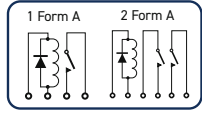

Series 110

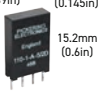
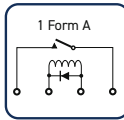
Series 112



General Purpose SIL Reed Relays

- Ideal for General Purpose & High Density ATE/Instrumentation applications
- Plastic package with internal mu-metal magnetic screen
- 3V, 5V, 12V or 24V coils. Diodes are Optional
- Dry Instrument Grade switches
- SoftCenter™ Technology

Series 113

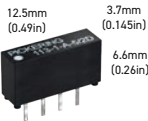

Series 111P

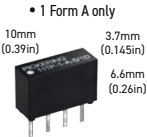

Series 109P

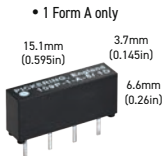

Series 106

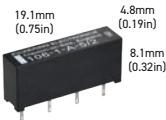

Series 105

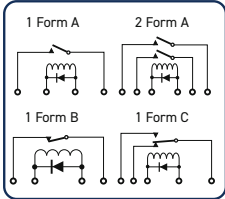
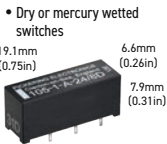

Mu-Metal Package SIL Reed Relays

- Ideal for General Purpose & High Density ATE/Instrumentation applications
- Mu-metal package eliminating the risk of magnetic interaction
- 3V, 5V, 12V or 24V coils. Diodes are Optional
- Dry Instrument Grade switches
- SoftCenter™ Technology

Series 111

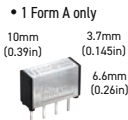

Series 109

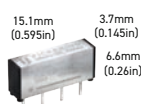

Series 108

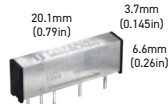

Series 107

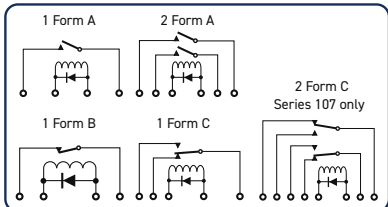
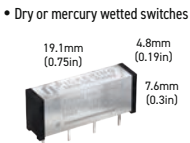

Low Power/Low Thermal EMF Reed Relays

- Ideal for Data Acquisition or thermo-couple switching
- Plastic package with internal mu-metal magnetic screen
- 3V, 5V, 12V or 24V coils. Diodes are Optional
- Dry Instrument Grade or Mercury Wetted switches
- SoftCenter™ Technology

Series 118

- 1 Form A only
- High Coil Resistance for Portable Instrumentation

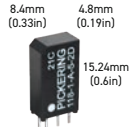

Series 101

- Direct Drive from HC or HCT CMOS

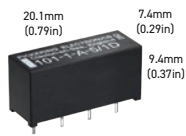

Series 100

- Direct Drive from CMOS

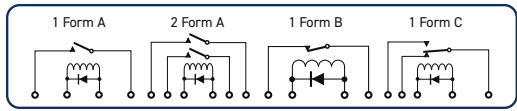
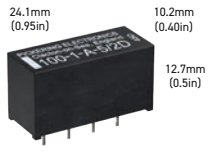

RF/High Speed Digital Reed Relays

- Ideal for High Density ATE/Instrumentation applications
- Mu-metal or Plastic package with internal magnetic screen
- 3V, 5V, or 12V coils. Diodes are Optional
- Dry Instrument Grade switches
- SoftCenter™ Technology

Series 111RF

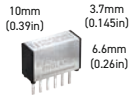

Series 109RF

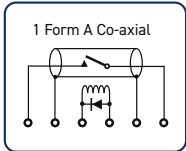
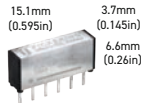

Series 103G

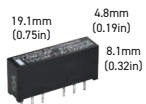

Series 102M

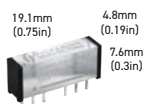

See also Surface Mount Series 200 Coaxial version.

High Voltage/High Power Reed Relays

- Ideal for high power/voltage applications
- Plastic package with internal mu-metal magnetic screen
- 3V, 5V, 12V or 24V coils. Diodes are Optional
- Dry Instrument Grade switches
- SoftCenter™ Technology

Series 114

- High Power up to 40W
- Will replace mercury wetted relays in many applications

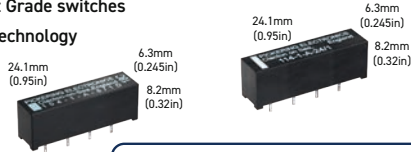

Series 104

- High Voltage up to 3000V
- Single Pole Relays up to 3kV Standoff
- Double Pole Relays up to 1.5kV Standoff

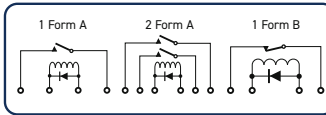

Series 119

- High Voltage up to 3000V
- Single Pole Relays up to 3kV Standoff
- Double Pole Relays up to 1.5kV Standoff

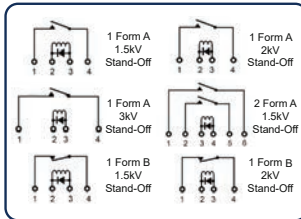
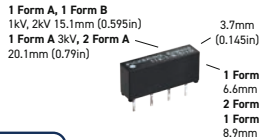

Series 131

NEW

- 1 Form A only
- Minimum 1.5kV Standoff

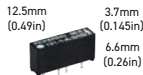

Series 67/68

- High Voltage up to 10kV
- Robust 50 Watts Tungsten contacts
- Series 67 has pcb pins for all connections. Series 68 has flying leads from the top face for the high voltage connections
- 1 Form A. Standing off 5kV, switching up to 3.5kV
- 1 Form A. Standing off 10kV, switching up to 7.5kV
- 1 Form C. Standing off 5kV, switching up to 2.5kV

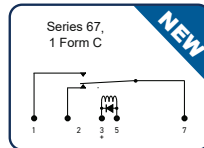

NEW

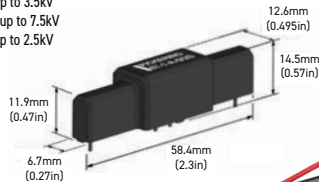
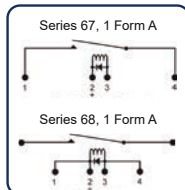

Ultra High Density 4mm²™ Reed Relays

NEW

- Highest packing density currently possible - requires a board area of only 4mm x 4mm
- Plastic package with internal mu-metal magnetic screen
- SoftCenter™ Technology

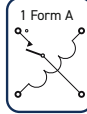

Series 120

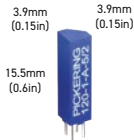

- Switching up to 1A, 20W
- 3, 5 or 12V coils

Series 122

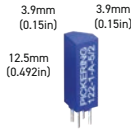

- Switching up to 0.5A, 10W
- 3 or 5V coils

Series 124

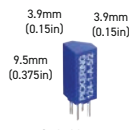

- Switching up to 0.5A, 10W
- 3 or 5V coils

Surface Mount Reed Relays

- Ideal for High Density ATE/Instrumentation applications
- High temperature plastic package with internal magnetic screen
- Wide range of switching configurations
- Coaxial version for high speed digital or R.F. to 5GHz.
- 3, 5 or 12 volt coils with optional diode
- Dry Instrument Grade or Mercury Wetted switches
- SoftCenter™ Technology

Series 200

1 Form A, 1 Form A Coaxial

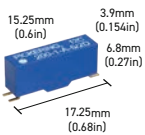

1 Form B, 2 Form A

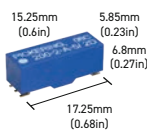

1 Form A - HV, Dry or Mercury 1 Form C

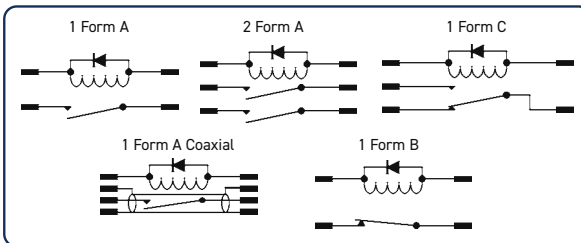
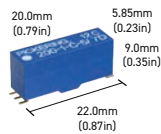



Pickering Electronics Ltd.
Stephenson Road
Clacton-on-Sea
CO15 4NL
United Kingdom

Tel (Int): + (44) 1255 428141
Tel (UK): 01255 428141
E-Mail: sales@pickeringrelay.com

© Copyright (2021) Pickering Electronics Ltd. All Rights Reserved. Pickering Electronics maintains a commitment to continuous product development, consequently we reserve the right to vary from the descriptions given in this catalogue.